

**NFPA 99 Compliant Duplex "Oil-Less" Scroll Medical Air Package
 10 HP Horizontal Tank Mounted with Single Point Connection and Desiccant Dryers**
Air Compressor Package

- Fully compliant with the latest edition of NFPA 99
- Two "oil-less" scroll air compressors with inlet filter, isolation valve and high inlet vacuum switch for each
- Two motors
- ASME coded corrosion resistant air receiver with bypass
- Duplex desiccant air dryer system with purge control and piped with duplex pre-filters, after filters and regulators
- Duplex control panel with HMI control monitoring system
- All discharge air piping and fittings - ASTM B-819 copper tubing, brass and/or stainless steel
- All brazed joints are per NFPA 99
- All discharge flex connectors - braided, 304 stainless steel
- Individual compressor isolation valve
- All components completely pre-piped and pre-wired to single point service connections
- All interconnecting piping and wiring is completed and operationally tested prior to shipment
- Liquid tight conduit, fittings and junction boxes for all control and power wiring

Air Compressor Module

- Continuous duty rated with permanently lubricated, sealed bearings
- Air-cooled single stage scroll type
- Constructed of one fixed and one orbiting scroll sealed with PTFE tip seals between the scroll halves
- Rated for 120 psig discharge pressure
- Protected from dust or contamination with a two part face seal
- Orbiting bearings - grease filled
- Drive Bearings – Grease filled and lip sealed
- Drive bearing maintenance interval – 10,000 hours
- Scroll housing constructed of die cast aluminum
- Integral cooling fan and air ducting for maximum heat dissipation
- Air-cooled aftercoolers for each compressor module with maximum approach temperature of 15° F and automatic solenoid drain valves
- V-belt drive with means of adjustment
- OSHA approved, totally enclosed belt guard
- High discharge air temperature shutdown switch wired to the compressor control system for each compressor
- Discharge line valve for load-less starting
- Each compressor discharge line equipped with a safety relief valve, a check valve, isolation valve, and flex connector

Compressor Motor

- NEMA rated – Open drip proof
- 3600 RPM, with 1.15 service factor
- 208 or 230/460V

Vibration Isolation System

- Compressor and motor - fully isolated from the package base by means of a four-point, heavy duty, isolation system
- Minimum of 95% isolation efficiency
- Optional seismically restrained isolators at an additional cost

Air Receiver

- Galvanized and integrally mounted with 3-valve bypass
- ASME Code stamped and National Board Certified
- Rated for a minimum 200 PSIG design pressure
- Liquid level sight glass
- Safety relief valve
- Manual drain
- Automatic timed solenoid drain valve

Dryer/Filter/Regulator System

- Dual desiccant air dryers with an integral demand based purge saving control system
- Each dryer individually sized for peak calculated demand and capable of producing a 10° F (-12° C) pressure dew point
- High efficiency coalescing pre-filter rated for 0.01 micron on each dryer with automatic drain and element change indicator
- Particulate final line filters rated for 0.01 micron on each dryer with element change indicator
- Final line regulators and safety relief valves on each dryer
- Isolation valves to permit servicing without shutting down the medical air system
- Air sample port

Dew Point Hygrometer/CO Monitor

- Dew point hygrometer/CO monitor with integral chemical CO sensor - pre-piped, wired and includes remote alarm contacts
- Hygrometer sensor - ceramic type
- Accuracy - minimum of ± 2° F for dew point and ± 2 PPM (at 10 PPM) for carbon monoxide
- Dew point alarm - factory set at 36° F (2° C) per NFPA 99
- CO alarm - factory set at 10 PPM
- Both set points field adjustable
- High CO and dew point indicated with visual/audible alarms

Control System

- Mounted and wired duplex control system
- NEMA 12 and UL 508A labeled
- Automatic lead/lag sequencing
- Circuit breaker disconnects for each motor with external operators
- Full voltage motor starters with overload protection
- 120V control circuit transformers for each motor circuit
- Visual and audible reserve unit alarm with isolated contacts for remote alarm
- Hand-off-auto selector switches for reliable back-up
- Automatic alternation of compressors based on a first-on/first-off principle with provisions for simultaneous operation
- Automatic activation of reserve unit if required
- Visual and audible alarm indication for high discharge air temperature shutdown with isolated contacts for remote alarm
- SIGNAL 1™ – touch screen gateway

Standard Screen Displays

- | | |
|------------------------|--|
| + Air level/Runtime | + Replacement parts |
| + Alarm history | + Troubleshooting guidelines |
| + Service indicator | + Historical Trending of system status |
| + Maintenance schedule | |

- + 7" Wide TFT Graphic Touch Screen with Motion Actuated Backlit LED and Bright 65,536 (16-bit) Colors
- + Downloadable Trend Information via USB Host Port or Network Device
- + 128MB Flash Memory, 64MB DRAM
- + Built-in Ethernet Port 10/100 Base-T (RJ45)
- + Supports over 100 Communication Protocols including BACnet IP, Ethernet IP, and Modbus TCP/IP
- + Built-in Multiple Ports it can handle three (3) additional Protocols simultaneously
- + Built-in VNC server allowing remote monitoring over Ethernet/Internet network for "Real Time" monitoring of live graphics through standard browser, smart phones & mobile devices
- + Share data between HMI and Building Management systems with no additional software to implement

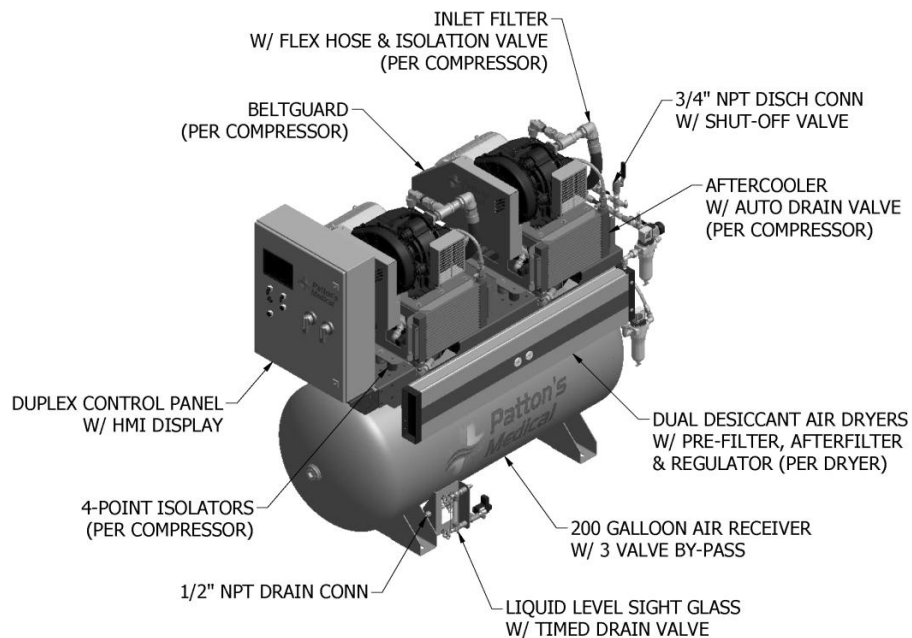
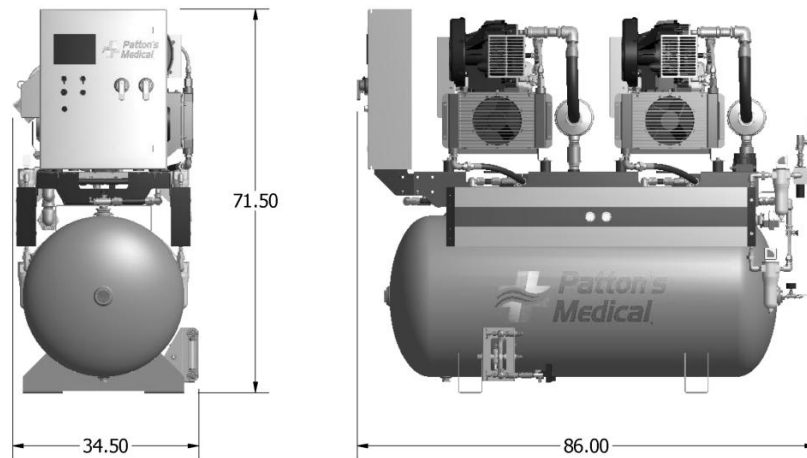

Duplex Scroll Medical Air Package Specifications ¹										
Package Model No.	HP	System Capacity ²		Package BTU/HR ³	Receiver	Noise Level ⁴	System FLA			Weight (lbs)
		50 psig	110 psig				208V	230V	460V	
62-21-104A	10	34.8	32.0	23,014	200 Gal.	73	60			1640
62-21-104B								52		
62-21-104C									26	

Notes:

¹ Normal Operating conditions at a maximum ambient of 105° F. Consult factory for higher ambient conditions.

² Capacities are shown as NFPA system capacities (reserve compressor on standby) and are shown in Inlet Cubic Feet per Minute (ICFM).

³ Package BTU/HR are shown with the reserve compressor on standby.

⁴ Noise levels are shown in dB(A) and reflect one compressor module running.

Assembly Diagram [62-21-104-ASM](#)

Installation Diagram [62-21-104-INT](#)

Piping Diagram [62-21-104-PID](#)

Statement of Warranty

Patton's Medical warrants all Medical Air packages, to be free of defects in material and workmanship under normal use for a period not to exceed thirty (30) months from date of shipment, or twenty-four (24) months from date of start-up.