

NFPA 99 Compliant Duplex Medical Air Desiccant Dryer System 8 SCFM with Regulators, Safety Relief Valves and Dew Point/CO Monitor

Duplex Dryer System

- Two desiccant twin tower air dryers with an integral demand based purge saving control system
- Two pre-filters
- Two after filters
- Two final line regulators and safety relief valves
- Four valve bypass for dryer maintenance
- Isolation valves to permit servicing without shutting down the medical air system
- Air sample port

Dryer

- Twin tower, pressure swing adsorption, regenerative type
- Each dryer individually sized for peak calculated demand and capable of producing a 10° F (-12° C) pressure dew point
- Desiccant is contained within a packed bed canister to prevent excessive downstream dusting
- Purge flow is minimized through an integral purge saving control system

Pre-filter

- High efficiency coalescing pre-filter rated for 0.01 micron mounted on each dryer with automatic drain and element change indicator
- Automatic solenoid drain valve for coalescing filter

After Filter

- Particulate final line filters rated for 0.01 micron mounted on each dryer with element change indicator

Regulator/ Safety Relief Valve

- Dual regulators
- Factory set @ 55 PSI with
- Safety relief valves rated for 75 PSI.

Dew Point Hygrometer/CO Monitor

- Dew point hygrometer/CO monitor with integral chemical CO sensor - mounted, pre-piped, wired and includes remote alarm contacts
- Hygrometer sensor - ceramic type
- Accuracy - minimum of $\pm 2^{\circ}$ F for dew point and ± 2 PPM (at 10 PPM) for carbon monoxide
- Dew point alarm - factory set at 36° F (2° C) per NFPA 99
- CO alarm - factory set at 10 PPM
- Set points are not field adjustable
- High CO and high dew point conditions indicated with visual and audible alarms.

Control System

- Mounted and wired control system
- Allows the operator to choose between manual purge and demand purge
- In manual purge, dryer will shift towers every 2 minutes
- Online tower re-pressurizes for 50 seconds
- 15% of system capacity used for purge air
- In demand purge, the dew point monitor controls the dryer purge as purging depends on dew point condition

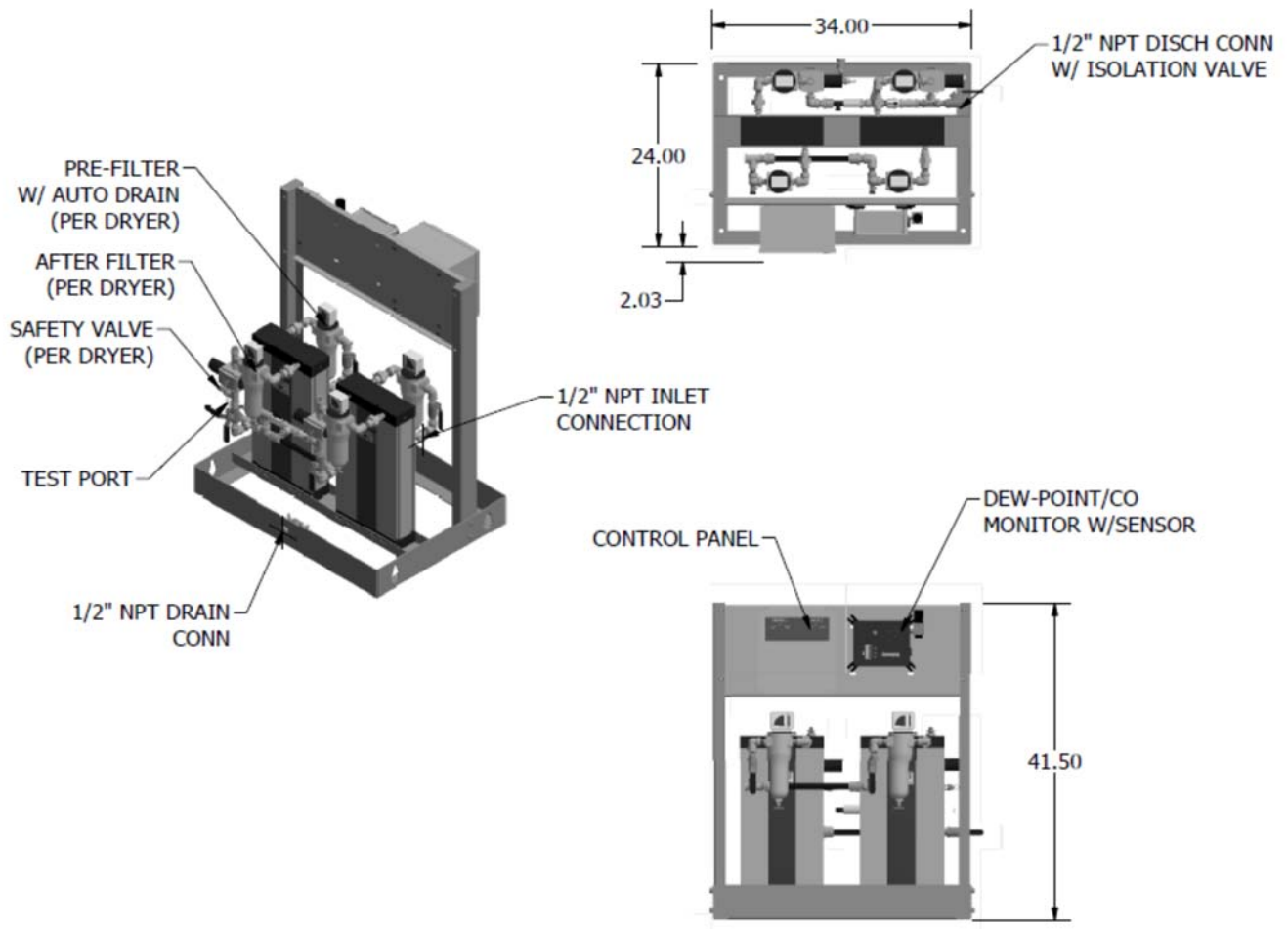

Model No: 64-02-008

Inlet Flow Capacity @ 100 psig: 8 scfm (reserve dryer on standby)

Inlet Connection: 1/2" NPT

Outlet Connection: 1/2" NPT

Electrical Requirement: 120V/1/60 Hz NEMA 4 Standard (100 Watts)

Minimum Working Pressure: 60 psig

Maximum Working Pressure: 125 psig

Maximum Inlet Temperature: 110° F

Statement of Warranty

Patton's Medical warrants all Medical Air Dryer packages, to be free of defects in material and workmanship under normal use for a period not to exceed thirty (30) months from date of shipment, or twenty-four (24) months from date of start-up.