

**NFPA 99 Compliant Duplex “Oil-Less” Claw Medical Vacuum Package
3 HP Vertical Stacked Base Mount Space Saver (Fixed Speed or VFD)**

Vacuum Package

- Fully compliant with the latest edition of NFPA 99
- Two oil-less rotary claw type vacuum pumps with inlet filter and isolation valve for each
- ASME coded vacuum receiver with bypass and manual drain
- Duplex control panel with automatic lead/lag controls
- All components completely pre-piped and pre-wired to single point service connections
- Vibration isolation mountings
- Liquid tight conduit, fittings and junction boxes for all control and power wiring
- All interconnecting piping and wiring is completed and operationally tested prior to shipment

Vacuum Pump

- Oil-less rotary claw pump
- Direct-driven through a shaft coupling
- Air-cooled
- End (ultimate) vacuum = 28" Hg
- Dry-running, with two claw-type, non-contacting rotors
- Sealing fluid not required
- Virtually maintenance-free operation
- High discharge temperature switch
- Oil change required at approximately 5,000 operating hour intervals in the gearbox only
- Built-in, anti-suck-back valve mounted at the pump inlet
- 2 micron inlet filter for removal of particulates

Vacuum Motor

- NEMA rated
- C-face
- TEFC
- 208 or 230/460V 3-phase

Vibration Isolation System

- Vacuum and motor - fully isolated from the package base by means of a four-point, heavy duty, isolation system
- Minimum of 95% isolation efficiency
- Optional seismically restrained isolators at an additional cost

Intake/Discharge Piping

- Vacuum pumps are connected to a common manifold and piped to a receiver
- Inlet check valve on each pump
- Inlet isolation valve on each pump
- Flexible connectors between pumps and manifold
- Flexible connectors for inlet and discharge connections
- Discharge flex connection shipped loose

Vacuum Receiver

- Horizontal orientation with integrally mounted bypass and manual drain
- ASME Code stamped
- National Board Certified
- Rated for a minimum 200 PSIG design pressure
- Vacuum gauge
- Manual drain

System Health

- Monitoring and Trending of key components to provide notification of potential issue with the Health of the System
- Vacuum monitoring
- Current monitoring for each motor
- Ambient Temperature monitoring
- Trending of pumps running

Control System

- Mounted and wired duplex control system
- NEMA 12 and UL 508A labeled
- **74v only:** Variable frequency drive to control one pump at a time
- Automatic lead/lag sequencing
- Circuit breakers
 - **74:** One for each motor with external operators
 - **74v:** One external disconnect, but internally one for VFD and one for each motor
- Full voltage motor starters with overload protection
- 120V control circuit transformers for each motor circuit
- Visual and audible reserve unit alarm with isolated contacts for remote alarm
- Hand-off-auto selector switches for reliable back-up
- Automatic alternation of compressors based on a first-on/first-off principle with provisions for simultaneous operation
- Automatic activation of reserve unit if required
- Visual and audible alarm indication for high discharge air temperature shutdown with isolated contacts for remote alarm
- SIGNAL 1™ – touch screen gateway

Standard Screen Displays

- | | |
|------------------------|--|
| + Air level/Runtime | + Replacement parts |
| + Alarm history | + Troubleshooting guidelines |
| + Service Indicator | + Historical trending of system status |
| + Maintenance Schedule | + System Health |

- 7" Wide TFT Graphic Touch Screen with Motion Actuated Backlit LED and Bright 65,536 (16-bit) Colors
- Downloadable Trend Information via USB Host Port or Network Device
- 128MB Flash Memory, 64MB DRAM
- Built-in Ethernet Port 10/100 Base-T (RJ45)
- Supports over 100 Communication Protocols including Ethernet IP, and Modbus TCP/IP
- Built-in VNC server allowing remote monitoring of live graphics through standard browser, smart phones & mobile devices
- Share data between HMI and Building Management systems

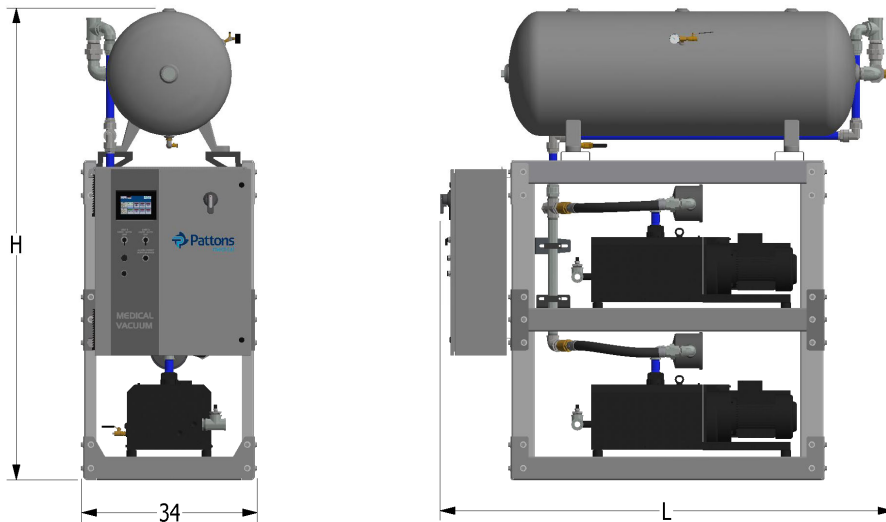
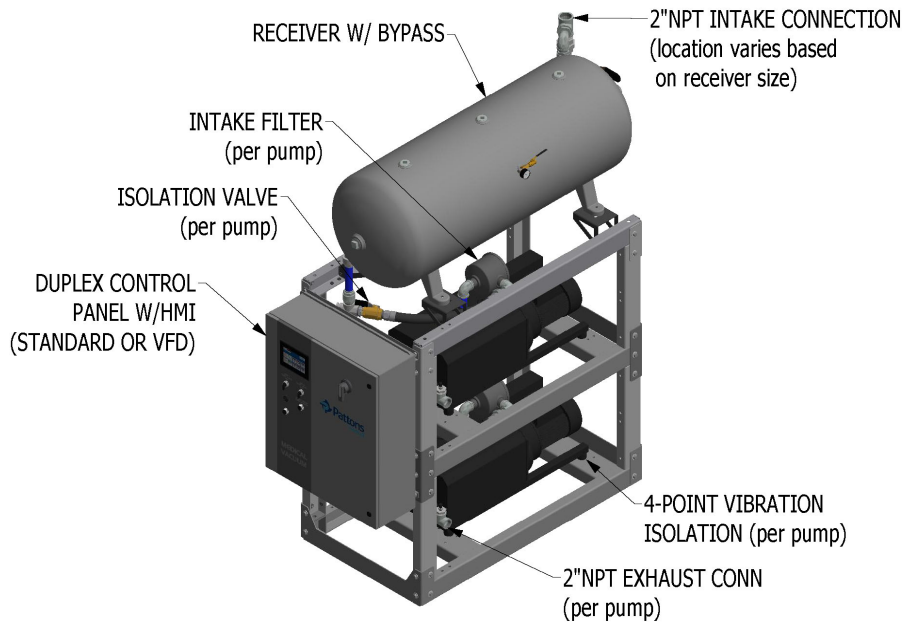

Duplex Claw Medical Vacuum Package Specification ¹											
Model Number	HP	Capacity @19" Hg ²		Package BTU/HR ³	Noise Level ⁴	System FLA			Receiver Size (gallons)	L/H (inches)	Package Weight (pounds)
		Pump (SCFM)	System (SCFM)			208V (A)	230 (B)	460 V (C)			
74-25-036(A/B/C)	3	21	21	7,650	70	19	18	9	60	67/80	1,668
74v-25-036(A/B/C)										74/80	1,700
74-25-032(A/B/C)									80	80/87	1,718
74v-25-032(A/B/C)										88/87	1,750
74-25-033(A/B/C)									120	80/91	1,760
74v-25-033(A/B/C)										88/91	1,886

Notes:

¹ Normal Operating conditions at a maximum ambient of 105° F. Consult factory for higher ambient conditions.

² Capacities are shown per NFPA 99 standard with one pump in reserve.

³ Package BTU/HR are shown with one pump in reserve.

⁴ Noise levels are shown in dB(A) and the reserve pump on standby.

Statement of Warranty

Patton's Medical warrants all Medical Air packages, to be free of defects in material and workmanship under normal use for a period not to exceed thirty (30) months from date of shipment, or twenty-four (24) months from date of start-up.