

**Simplex Oil-Less Scroll Lab Air Package 3 HP Tank Mount with Simplex Desiccant Air Dryer**
**Air Compressor Package**

- One oil-less scroll air compressor with inlet filter
- One motor
- ASME coded air receiver
- Simplex control panel
- All discharge air piping and fittings - ASTM B-819 copper tubing, brass and/or stainless steel
- All components completely pre-piped, pre-wired and tested prior to shipment

**Air Compressor Module**

- Continuous duty rated with permanently lubricated, sealed bearings
- Single stage scroll type
- Air-cooled
- Constructed of one fixed and one orbiting scroll sealed with PTFE tip seals between the scroll halves
- Rated for 120 psig discharge pressure
- Protected from dust or contamination with a two part face seal
- Orbiting bearings - grease filled
- Drive Bearings – Grease filled and lip sealed
- Drive bearing maintenance interval – 10,000 hours
- Scroll housing constructed of die cast aluminum
- Mounted air-cooled aftercooler
- V-belt drive with means of adjustment
- OSHA approved, totally enclosed belt guard
- Each compressor discharge line equipped with a safety relief valve and check valve

**Compressor Motor**

- NEMA rated
- Open drip proof
- 3600 RPM, with 1.15 service factor
- 208 or 230/460V

**Air Receiver**

- ASME Code stamped
- National Board Certified
- Rated for a minimum 200 PSIG design pressure
- Safety relief valve
- Auto drain valve

**Control System**

- Mounted and wired simplex control panel
- NEMA 12 and U.L. labeled
- Pressure gauge
- Runtime hourmeters
- Full voltage motor starter with overload protection
- 120V control circuit transformer
- Off/On illuminated selector switch

**Dryer/Filter System**

- Simplex desiccant air dryer with purge saving
- High efficiency coalescing pre-filter rated for 0.01 micron mounted on each dryer with automatic drain and element change indicator
- Particulate final line filters rated for 0.01 micron mounted on each dryer with element change indicator

**OPTIONAL**
**Vibration Isolation System**

- Four-point heavy duty isolators
- Seismically restrained isolators

**Air Receiver**

- Galvanized
- 3 valve by-pass
- Sight glass

**Dryer/Filter/Regulator System**

- Final line regulator and safety relief valve mounted on dryer
- Air sample port
- Simplex refrigerated dryer
- Dryer by-pass valves

**Dew Point Hygrometer/CO Monitor**

- Dew point hygrometer mounted, pre-piped, wired and includes remote alarm contacts
  - Hygrometer sensor - ceramic type
  - Accuracy - minimum of  $\pm 2^\circ$  F for dew point
  - Dew point alarm - factory set at 36° F (2° C)
  - Set point is field adjustable
  - High dew point conditions indicated with visual and audible alarms
- CO Monitor with integral chemical CO sensor - mounted, pre-piped, wired and includes remote alarm contacts
  - Accuracy - minimum of  $\pm 2$  PPM (at 10 PPM) for carbon monoxide
  - CO alarm - factory set at 10 PPM
  - Set points field adjustable
  - High CO indicated with visual and audible alarms

**Control System**

- High discharge air temperature switch with remote alarm
- High inlet vacuum switch
- Circuit breaker
- Circuit breaker with through the door disconnect
- SIGNAL 1™ – touch screen gateway

**Standard Screen Displays**

- + Air level/Runtime
- + Alarm history
- + Service indicator
- + Maintenance schedule
- + Replacement parts
- + Troubleshooting guidelines
- + Historical Trending of system status
- + 7" Wide TFT Graphic Touch Screen with Motion Actuated Backlit LED and Bright 65,536 (16-bit) Colors
- + Downloadable Trend Information via USB Host Port or Network Device
- + 128MB Flash Memory, 64MB DRAM
- + Built-in Ethernet Port 10/100 Base-T (RJ45)
- + Supports over 100 Communication Protocols including BACnet IP, Ethernet IP, and Modbus TCP/IP
- + Built-in Multiple Ports it can handle three (3) additional Protocols simultaneously
- + Built-in VNC server allowing remote monitoring over Ethernet/Internet network for "Real Time" monitoring of live graphics through standard browser, smart phones & mobile devices
- + Share data between HMI and Building Management systems with no additional software to implement

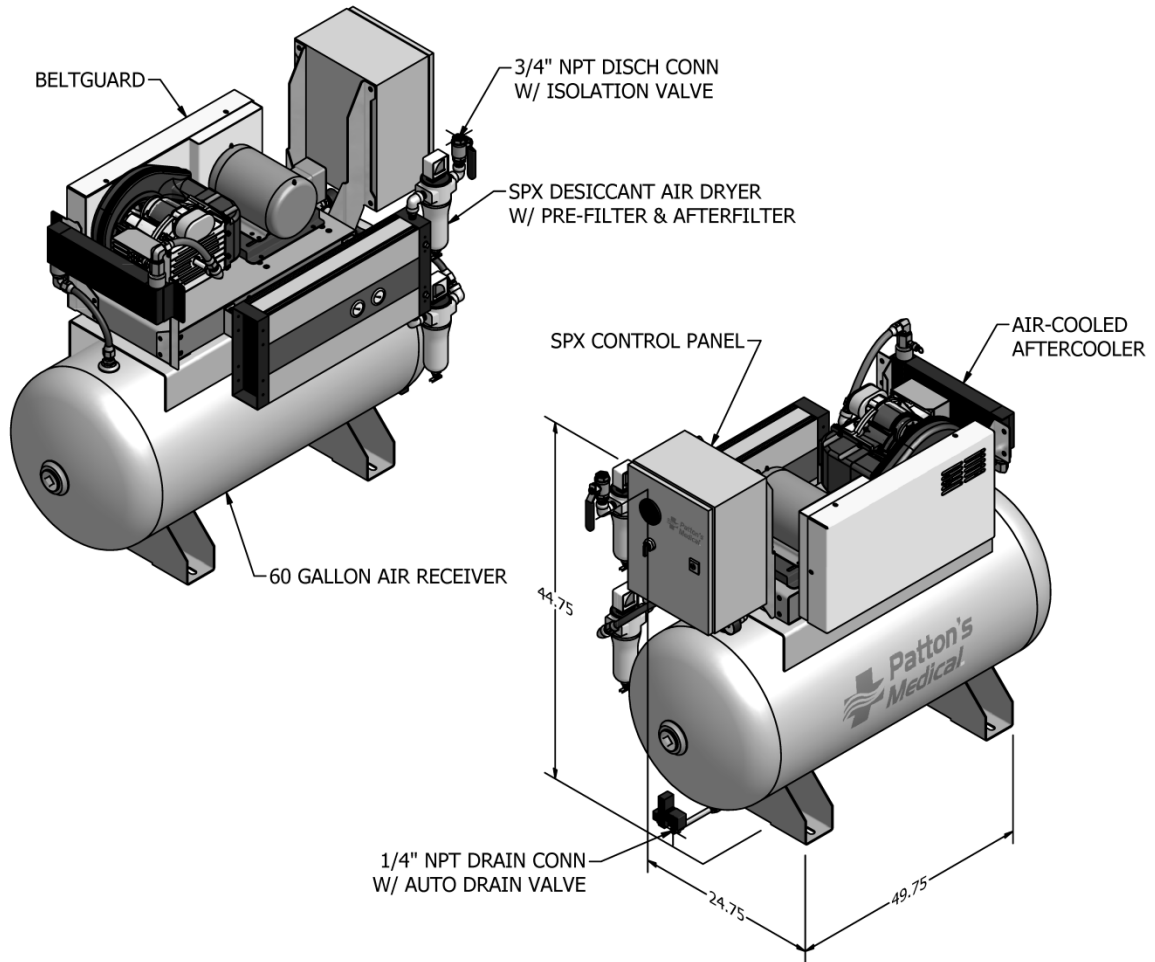

Simplex Scroll Lab Air Package Specifications <sup>1</sup>										
Complete Package Model No.	HP	System Capacity <sup>2</sup>		Package BTU/HR	Receiver	Noise Level <sup>3</sup>	System FLA			Weight
		50 psig	110 psig				A 208V	B 230V	C 460V	
68d-11-036A	3	10.4	9.6	6,745	60 Gal.	69	11	10	5	470
68d-11-036B										
68d-11-036C										

Notes:

<sup>1</sup> Normal Operating conditions at a maximum ambient of 105° F. Consult factory for higher ambient conditions.

<sup>2</sup> Capacities are shown as system capacities and are shown in Inlet Cubic Feet per Minute (ICFM).

<sup>3</sup> Noise levels are shown in dB(A).

**Statement of Warranty**

Patton's Medical warrants all Control Air packages, to be free of defects in material and workmanship under normal use for a period not to exceed thirty (30) months from date of shipment, or twenty-four (24) months from date of start-up.