

## NFPA 99 Compliant Duplex Medical Air Desiccant Dryer System 35 SCFM with Regulators, Safety Relief Valves and Dew Point/CO Monitor

### Duplex Dryer System

- Two desiccant twin tower air dryers with an integral demand based purge saving control system
- Two pre-filters
- Two after filters
- Two final line regulators and safety relief valves
- Four valve bypass for dryer maintenance
- Isolation valves to permit servicing without shutting down the medical air system
- Air sample port

### Dryer

- Twin tower, pressure swing adsorption, regenerative type
- Each dryer individually sized for peak calculated demand and capable of producing a 10° F (-12° C) pressure dew point
- Desiccant is contained within a packed bed canister to prevent excessive downstream dusting
- Purge flow is minimized through an integral purge saving control system

### Pre-filter

- High efficiency coalescing pre-filter rated for 0.01 micron mounted on each dryer with automatic drain and element change indicator
- Automatic solenoid drain valve for coalescing filter

### After Filter

- Particulate final line filters rated for 0.01 micron mounted on each dryer with element change indicator

### Regulator/ Safety Relief Valve

- Dual regulators
- Factory set @ 55 PSI with
- Safety relief valves rated for 75 PSI.

### Dew Point Hygrometer/CO Monitor

- Dew point hygrometer/CO monitor with integral chemical CO sensor - mounted, pre-piped, wired and includes remote alarm contacts
- Hygrometer sensor - ceramic type
- Accuracy - minimum of  $\pm 2^{\circ}$  F for dew point and  $\pm 2$  PPM (at 10 PPM) for carbon monoxide
- Dew point alarm - factory set at 36° F (2° C) per NFPA 99
- CO alarm - factory set at 10 PPM
- Set points are not field adjustable
- High CO and high dew point conditions indicated with visual and audible alarms.

### Control System

- Mounted and wired control system
- Allows the operator to choose between manual purge and demand purge
- In manual purge, dryer will shift towers every 2 minutes
- Online tower re-pressurizes for 50 seconds
- 15% of system capacity used for purge air
- In demand purge, the dew point monitor controls the dryer purge as purging depends on dew point condition

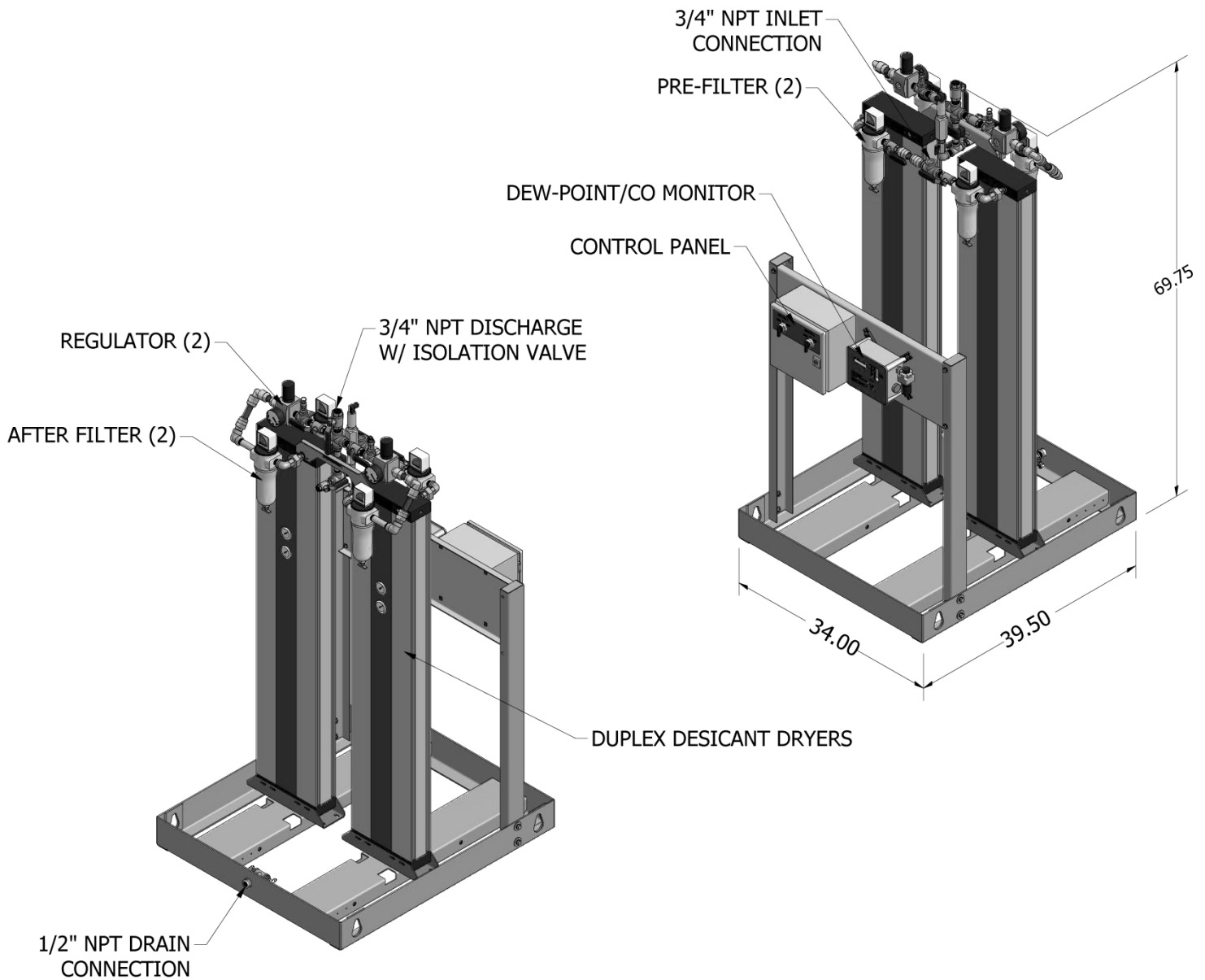

**Model No: 64-02-035**

**Inlet Flow Capacity @ 100 psig: 35 scfm (reserve dryer on standby)**

**Inlet Connection: 3/4" NPT**

**Outlet Connection: 3/4" NPT**

**Electrical Requirement: 120V/1/60 Hz NEMA 4 Standard (100 Watts)**

**Minimum Working Pressure: 60 psig**

**Maximum Working Pressure: 125 psig**

**Maximum Inlet Temperature: 110° F**

**Statement of Warranty**

**Patton's Medical** warrants all Medical Air Dryer packages, to be free of defects in material and workmanship under normal use for a period not to exceed thirty (30) months from date of shipment, or twenty-four (24) months from date of start-up.